



ADVANCES IN FOREST FIRE RESEARCH 2018

EDITED BY

DOMINGOS XAVIER VIEGAS
ADAI/CEIF, UNIVERSITY OF COIMBRA, PORTUGAL

Measurement of pyrolysis products from mixed fuel beds during fires in a wind tunnel

David R. Weise^{1*}; Timothy J. Johnson², WeiMin Hao³, Marko Princevac⁴, Nicole Scharko², Ashley Oeck², Tanya L. Myers², Steve Baker³, Emily Lincoln³, AmirHessam Aminfar⁴

¹USDA Forest Service, PSW Research Station, 4955 Canyon Crest Dr., Riverside, California, USA 92507, {dweise@fs.fed.us*}

² Pacific Northwest National Laboratory, Richland, Washington, USA 99354, {timothy.johnson@pnnl.gov}

³ USDA Forest Service, Rocky Mountain Research Station, Missoula, Montana, , {whao@fs.fed.us}

⁴ Mechanical Engineering Dept., University of California-Riverside, Riverside, California, USA, {marko.princevac@ucr.edu, aamin006@ucr.edu}

Abstract

Pyrolysis of intact wildland fuels in the southern United States is being measured at bench, wind tunnel, and field scales as part of a larger research project to measure and model pyrolysis of wildland fuels to improve models used to predict prescribed fire behavior. Traditional pyrolysis experiments typically use dried, ground samples in either an inert or oxidizing environment subject to uniform heating and heat transfer. Fletcher and others are presenting results of pyrolysis experiments using a flat-flame burner to heat intact foliage from 14 species of plants native to the southern U.S. at this conference. The fuel beds in prescribed burns in southern pine forests are composed of a mixture of dead pine needles and a large variety of herbaceous and woody plants. We have burned 73 fuel beds composed of *Pinus palustris* needles and mixtures of *Lyonia lucida*, *Ilex glabra*, and *Vaccinium darrowii* plants in a wind tunnel facility with and without a moderate wind speed of ~ 1 m s⁻¹. The flame from the spreading fire is the heat source for the pyrolysis experiment. Canister samples of pyrolysis and flaming combustion gases within the fuel bed have been collected for offline analysis. Open path spectrometers nonintrusively measured composition of pyrolysis gases in real-time. Thermocouples, a Schmidt-Boelter heat flux sensor, a nadir thermal IR camera, and background-oriented Schlieren photography estimated heat transfer and air flow around the plants. This presentation will present results of this ongoing work.

Keywords: pyrolysis, longleaf, fetterbush, inkberry, sparkleberry, background-oriented Schlieren

1. Introduction

Wildland fire is an important component of many North American ecosystems and has been used by humans to accomplish various objectives for several thousand years. Prescribed burning in the southern United States is an important tool used by the Department of Defense and other land managers to accomplish several objectives including hazardous fuel reduction, wildlife habitat management, critical training area maintenance, ecological forestry and infrastructure protection. The vegetation on Department of Defense installations is heterogeneous, unlike the homogeneous fuel beds assumed by current operational fire spread models. These models do not contain fundamental descriptions of chemical reactions and heat transfer processes necessary to predict fire spread and energy release needed for process-based fire effects models. To improve prescribed fire application to accomplish desired fire effects and limit potential escapes, an improved understanding is needed of the fundamental processes related to pyrolysis and ignition in heterogeneous fuel beds of live and dead fuels. A large project consisting of measurement and modeling of pyrolysis from common wildland fuels of the southern United States is currently underway (Weise *et al.* 2018). Details of the bench-

scale measurement of pyrolysis products from these fuels (individual leaves) can be found in (Fletcher *et al.* 2018; Safdari *et al.* 2018). A subset of the fuels have been burned as fuel beds approximating natural fuel beds in a small wind tunnel where similar pyrolysis measurements have been made. This paper presents details of the wind tunnel experiment and some preliminary results.

2. Methods

Approximately 100 experiments are planned for the low speed wind tunnel located at the Riverside Fire Laboratory (RFL) (Figure 1). The initial construction and subsequent modification to provide precise control of temperature and humidity within the test section are described elsewhere (Lozano 2011; Bartolome 2014). Fuel beds 2 m long and approximately 1 m wide composed of longleaf pine needles and various combinations of fetterbush, sparkleberry, and inkberry (Table 1) will be burned with nominal wind speeds of 0 and 1 m s⁻¹. Pyrolysis gases were sampled in real-time using a variety of methods and instruments (Figure 2). A Bruker Tensor 37 FTIR spectrometer¹ was deployed; note that this is the same device used in conjunction with the flat-flame burner measurements performed at BYU (Fletcher *et al.* 2018; Safdari *et al.* 2018). For the RFL experiments, the resolution was set to 4 cm⁻¹, the acquisition mode was set to double sided, forward-backward, the apodization function was Blackman-Harris 3-Term, and phase correction mode was Mertz (1967) with a zerofilling factor of 2. In order to increase temporal resolution, the number of scans was set to 1 with continuous measurements to obtain a spectral time resolution of 0.2 seconds. This instrument configuration is referred to as an “extractive FTIR” because it consists of a probe with 3/8” metal tubing connected to extract the gas into the cell using a roughing pump. The probe was placed above a plant during measurements (Figure 3) and gases were extracted from the wind tunnel into the gas cell before, during and after the flame had passed the plant. Absorbance spectra (A) were collected in real time where I_S represents the intensity of the single beam spectrum of the sample during smoke measurement and I_0 is the single beam spectrum of the of the reference measurement (Eq. (1)). The reference measurement was collected when the instrument and gas cell were purged with high purity nitrogen gas; N₂ does not absorb in the IR.

Table 1 - Southern plant species used in wind tunnel pyrolysis experiments.

Common name	Scientific name ¹
Inkberry	<i>Ilex glabra</i> (L.) A. Gray
Fetterbush	<i>Lyonia lucida</i> (Lam.) K. Koch
Sparkleberry	<i>Vaccinium arboreum</i> Marshall
Darrow’s blueberry	<i>Vaccinium darrowii</i> Camp “Rosa’s Blush”
Longleaf pine litter	<i>Pinus palustris</i> Mill.

1. USDA, NRCS. 2018. The PLANTS Database (<http://plants.usda.gov>, 10 January 2018). National Plant Data Team, Greensboro, NC 27401-4901 USA; Radford, A.E., Ahles, H.E., Bell, C.R. 1968. Manual of the vascular flora of the Carolinas, University of North Carolina Press, Chapel Hill, NC

¹ The use of trade or firm names in this publication is for reader information and does not imply endorsement by the U.S. Department of Agriculture of any product or service.

$$A = -\log\left(\frac{I_s}{I_0}\right) \quad (1)$$

The other FTIR instrument used for gas phase measurements was a Bruker OPAG-22, an open path gas analyzer previously used to measure smoke from prescribed burns at Ft. Jackson, South Carolina (Akagi *et al.* 2014). Unlike the extractive FTIR, this instrument is non-disrupting since it does not remove any of the gases from the wind tunnel, i.e. it does not perturb the sample. The OPAG was mounted on a tripod on one side of the wind tunnel with the glow bar IR source on the opposite side. The path between the OPAG and the source was 1.2 meters and it was directly in line with a row of plants (Figure 5). The OPAG is equipped with a KBr beamsplitter and a Stirling-cycle cooled mercury cadmium telluride (MCT) detector. Interferograms were collected in the range of 4000 to 0 cm^{-1} at a resolution of 2 cm^{-1} and at an acquisition mode set to double-sided forward-backward. To achieve better time resolution between measurements, interferograms were converted to spectra via post process procedures. The apodization function and phase correction mode were as above. The number of scans per measurement was set to 1 and the measurements were repeatedly collected to obtain a time profile with a resolution (time between spectra) of 0.53 seconds. The third instrument deployed was the TELOPS, an infrared hyperspectral imaging system that has high spectral and spatial resolution. Due to interference from the flame, the TELOPS will not be discussed further. Canister gas samples were collected for offline analysis using gas chromatography. An array of 9 stainless steel tubes were inserted vertically into the fuel bed (Figure 4). A sample of the flaming gases was collected in one canister and a sample of pyrolysis gases was collected from the other 6 tubes sequentially as the flame front moved horizontally along the fuel bed.

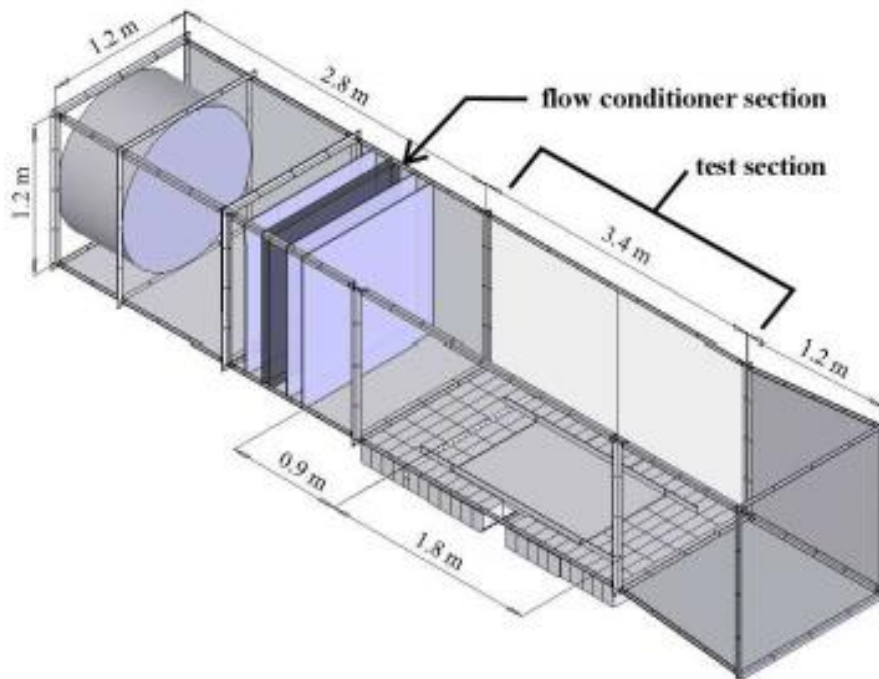

Figure 1 - Low speed wind tunnel at Riverside Fire Laboratory.

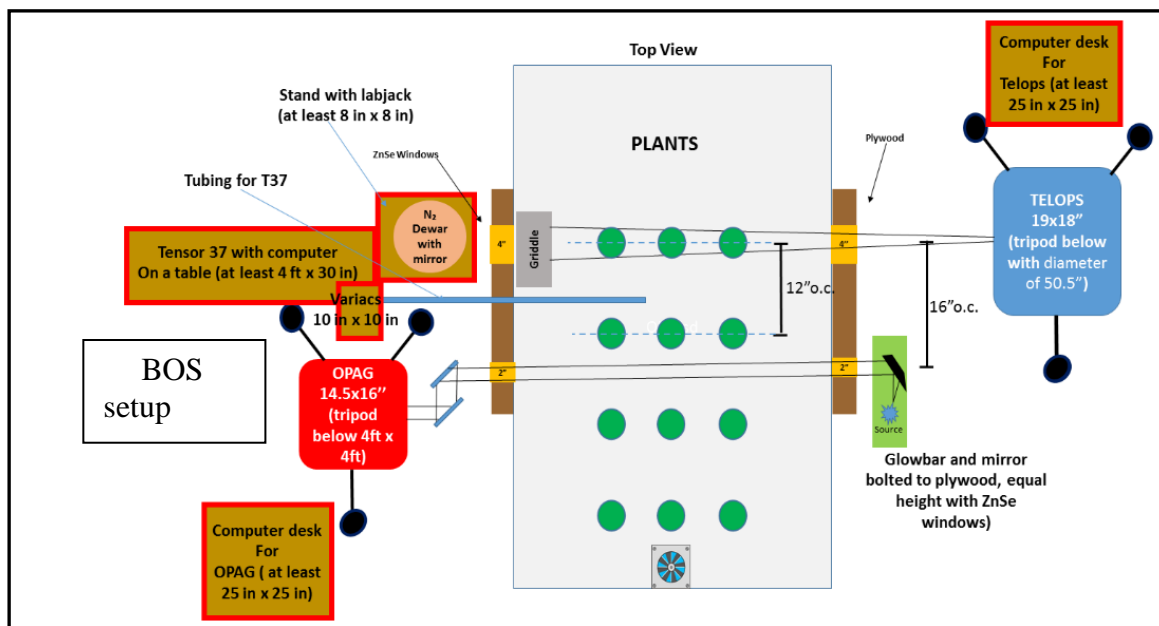

Figure 2 - Setup of 3 instruments used to measure composition of gaseous pyrolysis products in mixed fuel beds of longleaf pine needles and small shrubs.

In order to describe the environment and fuel properties as the plants were pyrolyzing, mass of a single plant, air temperature and relative humidity within the wind tunnel and in the larger combustion room were sampled at 1 hz during each experimental fire. While we have used a variety of techniques to describe the flow field around experimental laboratory fires (Zhou *et al.* 2003; Lozano *et al.* 2010; Maynard *et al.* 2016), the use of smoke tracers and introduced particles in the present experiment was precluded by the gas sampling objective. The TPIV technique could not be used because the large glass windows in the wind tunnel are opaque to the infrared spectrum. The background-oriented Schlieren (BOS) approach was selected to determine the flow field in the flame and surrounding the plants (Richard and Raffel 2001; Meier 2002; Raffel 2015). The BOS setup (Figure 5) was located upwind of the PNNL gas sampling instruments. Total and radiant heat fluxes at the top of the fuel bed were measured using a Schmidt-Boelter type of sensor. A stereo pair of vertical photographs of each fuel bed were taken before and after each experimental fire to develop 3-D images of the fuel bed (Figure 6). A longwave infrared (LWIR) camera provided a nadir view of the fuel bed and the measured radiance from the fuel bed will be converted into a fuel surface temperature (Figure 7).

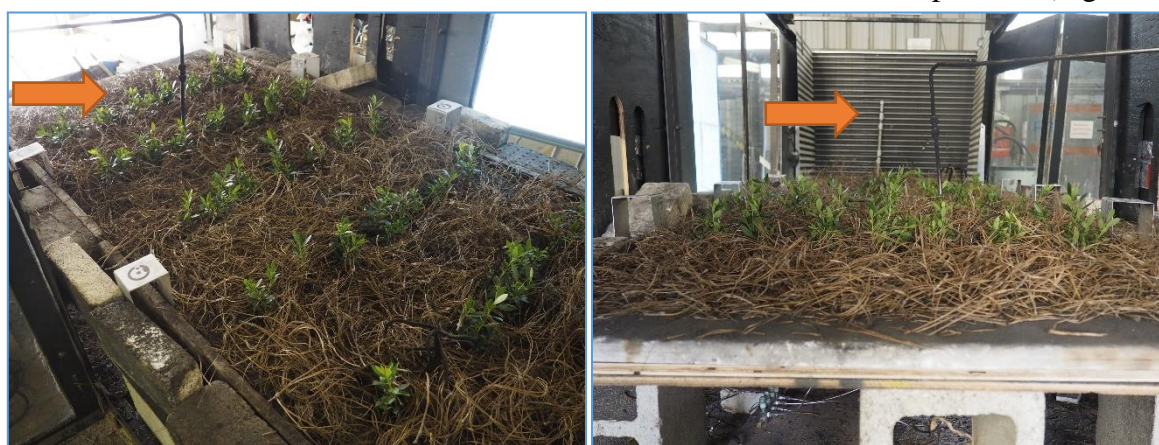

Figure 3 - Fuel bed composed of longleaf pine needles and *Lyonia lucida* plants. Sample probe to collect pyrolysis gases for the Bruker Tensor 37 is indicated by the arrow.



Figure 4 - Canister gas-sampling system with manifold (top) used to sample pyrolysis and flaming combustion gases from longleaf pine needle fuel beds through stainless steel tubes (bottom).

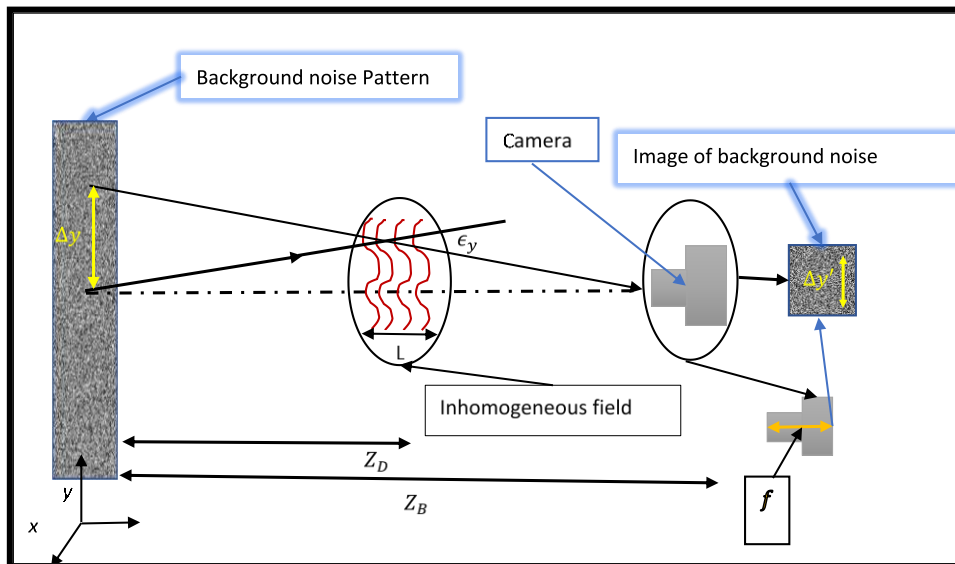

Figure 5 - Simple schematic of background-oriented Schlieren configuration used to nonintrusively estimate the flow field surrounding pyrolyzing plants. Z_D is the distance of the flame from the background noise pattern, Z_B is the distance of the camera lens from the background, ϵ_y represents the deflection angle caused by the flame-generated distortion, L is the flame zone width, f is the focal length of the camera, $\Delta y'$ represents displacement in the camera sensor plane and Δy represents displacement in the background plane.

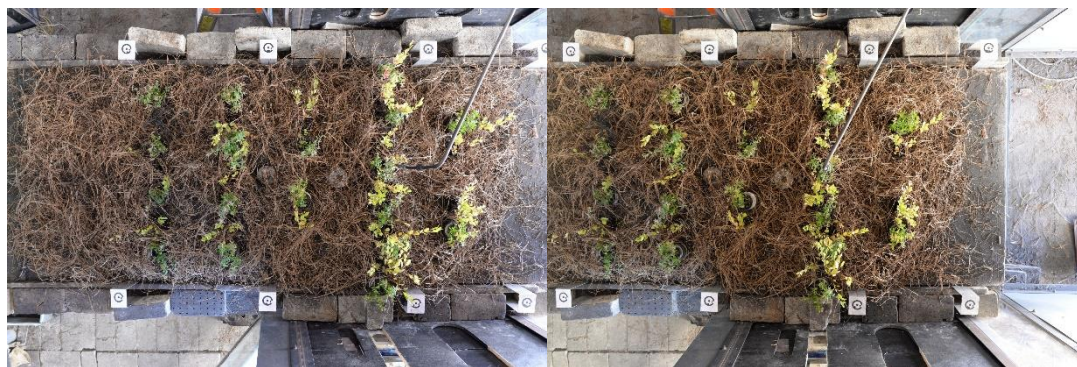

Figure 6 - Vertical stereo photographs of wind tunnel fuel bed used to provide 3D image.

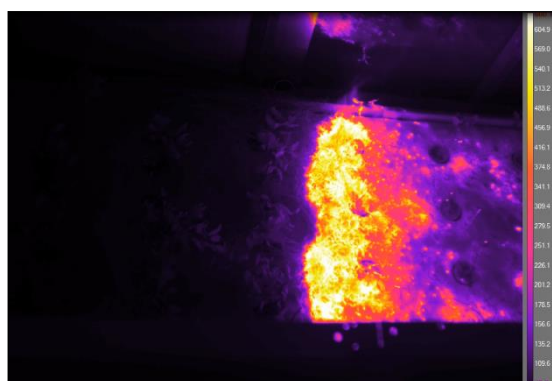

Figure 7 - Thermal infrared nadir view of fire spreading through fuel bed of longleaf pine needles and fetterbush shrubs in the RFL wind tunnel. Estimated temperature in °C.

3. Preliminary Results

Prior to beginning the wind tunnel experiments, the canister gas sampling setup and protocol was tested. Fires 3 and 4 consisted of longleaf pine needles only; needles and live plants comprised the fuel bed of fires 5 and 6. The composition of the gases from 6 canisters and the phase (pyrolysis or flaming combustion) was measured in ppm and converted to proportions to facilitate comparison since the data are compositional in nature (van den Boogaart and Tolosana-Delgado 2013). The proportions of CO, H₂, CH₄ and C₂H₆ were generally higher in the pyrolysis phase (Table 2) which is consistent with current understanding and indicated that the sampling system and protocol were appropriate. The modified combustion efficiency ($\Delta\text{CO}_2 / (\Delta\text{CO}_2 + \Delta\text{CO})$) of the pyrolysis samples were much lower than is typical for flaming combustion--another indication of elevated pyrolyzate concentrations. The use of this efficiency in the pyrolysis environment is questionable; however, the ratio is still useful. The flaming samples had typical emissions concentrations for the gases measured. The pine needle test fire results provide good background gas concentrations for that component of the fuel beds.

Table 2 - Sampled pyrolysis and combustion gases during preliminary testing of canister gas sampling system for wind tunnel experiment. Gas composition expressed as proportions.

Fire	Phase	CO ₂	H ₂	CO	CH ₄	C ₂ H ₆	MCE
5	Pyro	0.770755	0.039321	0.172521	0.016297	0.001105	0.82
6	Pyro	0.786460	0.036779	0.161488	0.014368	0.000905	0.83
5	Flam	0.924032	0.009898	0.061951	0.003959	0.000160	0.94
6	Flam	0.964003	0.003368	0.031151	0.001421	0.000058	0.97
3	Flam	0.898100	0.015933	0.080057	0.005687	0.000223	0.92
4	Flam	0.852222	0.030290	0.108157	0.008982	0.000349	0.89

To date, seventy-one wind tunnel experiments were conducted in November 2017 and January 2018 at RFL (Table 3). Forty-two of the fires were burned without wind. Wind increased the rate of spread appreciably which reduced the amount of time available to capture the pyrolysis gases. Gas samples were collected in canisters and are being processed at the Missoula Fire Sciences Lab. PNNL is analyzing the data collected by the two FTIR spectrometers.

Preliminary results from the BOS analysis to describe the fluid flow around the plants are promising. The images below are for the flame burning the pine needles fuels (Figure 8). The poster will contain more imagery and measurements resulting from this technique as well as information on the pyrolysis and flaming gases.

Table 3 - Brief description of wind tunnel experimental fires completed to date.

Month	NoWind/ Wind	Rate of spread (m/s)	Needle FMC (%)	Foliage FMC (%)
Nov. 2017	42/8	0.0057	10.3	112.9
Feb. 2018	0/21	0.0184	10.6	122.9

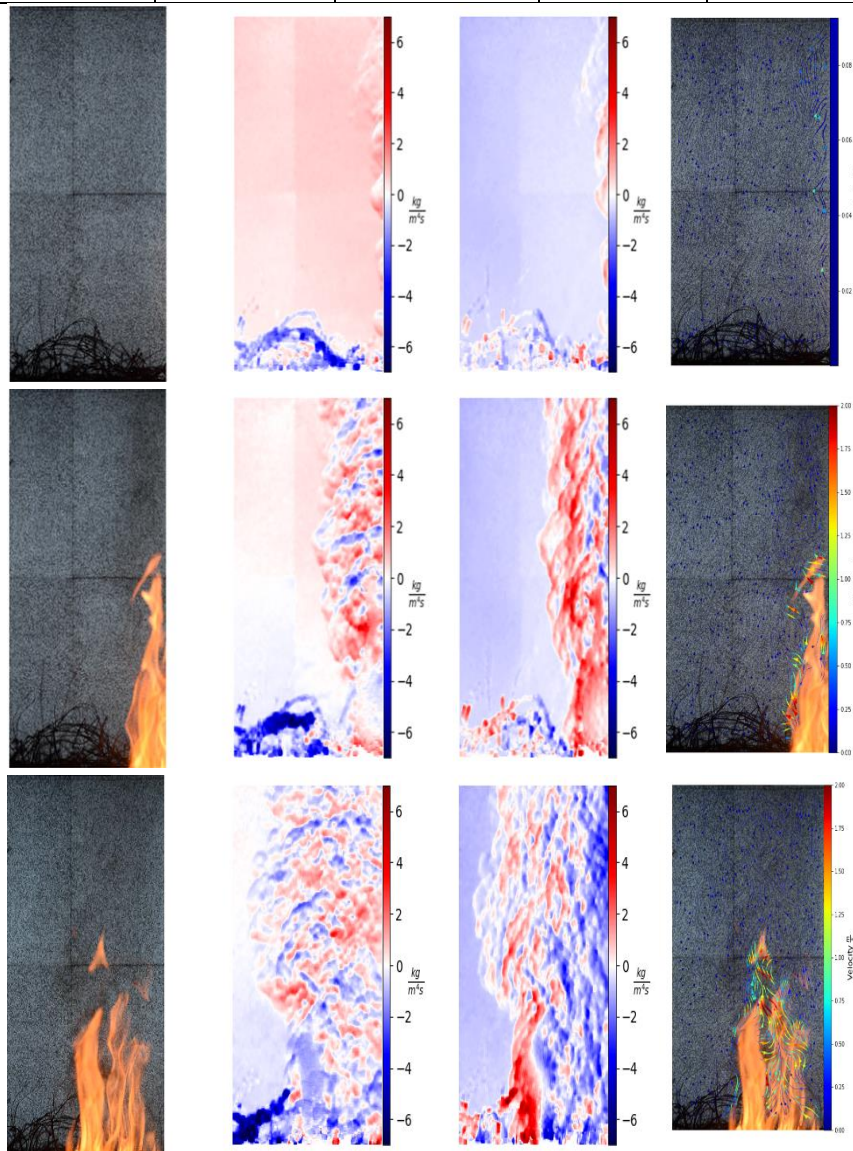

Figure 8 - Flow visualization of density gradients at three different times using a Background-oriented Schlieren technique. Time since ignition increases from the top frame to the bottom. The left column shows the actual image, the left middle column is the vertical density gradient ($\partial\rho/\partial y$) the right middle column is the horizontal density gradient ($\partial\rho/\partial x$), and the right column shows the estimated velocity vectors.

4. Acknowledgement

This work was supported was the DOD/EPA/DOE Strategic Environmental Research and Development Program project RC-2640.

5. Literature Cited

- Akagi SK, Burling IR, Mendoza A, Johnson TJ, Cameron M, Griffith DWT, Paton-Walsh C, Weise DR, Reardon J, Yokelson RJ (2014) Field measurements of trace gases emitted by prescribed fires in southeastern US pine forests using an open-path FTIR system. *Atmospheric Chemistry and Physics* **14**, 199–215. doi:10.5194/acp-14-199-2014.
- Bartolome CJ (2014) Formation of superfog from wildland fires: theoretical and physical modeling. Dissertation, University of California - Riverside, Riverside, CA. <http://scotty.ucr.edu/record=b4766864~S5>.
- van den Boogaart KG, Tolosana-Delgado R (2013) ‘Analyzing compositional data with R.’ (Springer: Heidelberg)
- Fletcher TH, Safdari M-S, Amini E, Weise DR (2018) Bench-scale measurement of pyrolysis products from intact live fuels. In ‘Adv. For. Fire Res. 2018’, Coimbra, Portugal. 3. (Coimbra University Press: Coimbra, Portugal)
- Lozano JS (2011) An investigation of surface and crown fire dynamics in shrub fuels. Dissertation, University of California, Riverside, CA.
- Lozano J, Tachajapong W, Weise DR, Mahalingam S, Princevac M (2010) Fluid dynamic structures in a fire environment observed in laboratory-scale experiments. *Combustion Science and Technology* **182**, 858–878. doi:10.1080/00102200903401241.
- Maynard T, Princevac M, Weise DR (2016) A study of the flow field surrounding interacting line fires. *Journal of Combustion* **2016**, 1–12. doi:10.1155/2016/6927482.
- Meier G (2002) Computerized background-oriented schlieren. *Experiments in Fluids* **33**, 181–187. doi:10.1007/s00348-002-0450-7.
- Mertz L (1967) Auxiliary computation for Fourier spectrometry. *Infrared Physics* **7**, 17–23. doi:10.1016/0020-0891(67)90026-7.
- Raffel M (2015) Background-oriented schlieren (BOS) techniques. *Experiments in Fluids* **56**,. doi:10.1007/s00348-015-1927-5.
- Richard H, Raffel M (2001) Principle and applications of the background oriented schlieren (BOS) method. *Measurement Science and Technology* **12**, 1576–1585. doi:10.1088/0957-0233/12/9/325.
- Safdari M-S, Rahmati M, Amini E, Howarth JE, Berryhill JP, Dietenberger M, Weise DR, Fletcher TH (2018) Characterization of pyrolysis products from fast pyrolysis of live and dead vegetation native to the Southern United States. *Fuel* **229**, 151–166. doi:10.1016/j.fuel.2018.04.166.
- Weise DR, Fletcher TH, Johnson TJ, Hao WM, Dietenberger M, Princevac M, Butler B, McAllister S, O’Brien J, Loudermilk L, Ottmar R, Hudak A, Kato A, Shotorban B, Mahalingam S, Mell WE (2018) A project to measure and model pyrolysis to improve prediction of prescribed fire behavior. ‘Adv. For. Fire Res. 2018’. (Coimbra University Press: Coimbra, Portugal)
- Zhou X, Sun L, Mahalingam S, Weise DR (2003) Thermal particle image velocity estimation of fire plume flow. *Combustion Science and Technology* **175**, 1293–1316. doi:10.1080/00102200302376.